

3160
Duct-Mount

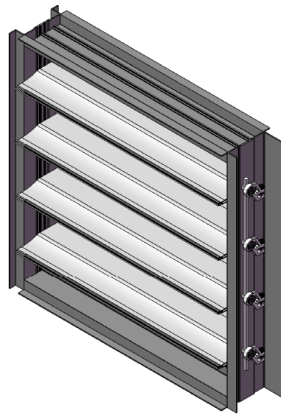

3161 Quick 'N' Stall
Duct-Mount

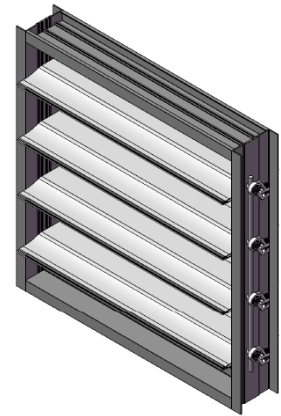

3165
Flanged-to-Duct

STANDARD CONSTRUCTION

Frame Depth: 4" (102 mm) – 3160/3165
5.25" (133 mm) – 3161
Overall Depth with Blades Open: 6.125" (156 mm)
Minimum Height: 8" (203 mm) - Single Blade
15" (381 mm) - Multiple Blade
Maximum Panel Width: 48" (1219 mm)
Maximum Panel Height: 60" (1524 mm)
Maximum Panel Size: 20 Sq.Ft.
Maximum System Pressure: See chart on page 2.
Operating Temperature Range: -40° to +180° F
Standard Finish: Mill extruded aluminum.
Standard Motor Installation: 6" Side Shaft Direct Drive
Linkage: Concealed in Frame (3160/3161)
Outside of Frame (3165)
Blade End Cap: Nylon

AVAILABLE ACCESSORIES

- Factory Supplied Actuators
- End Switch for signaling peripheral devices
- Jack Shaft
- Hand Quadrants
- Chain Operation for manual operation spring closed
- Silicone Blade and Jamb Seals – Specify 3100S/
- Salt Water Construction – Specify 3100SW
- Clear Anodized finish
- 4" Blade Construction

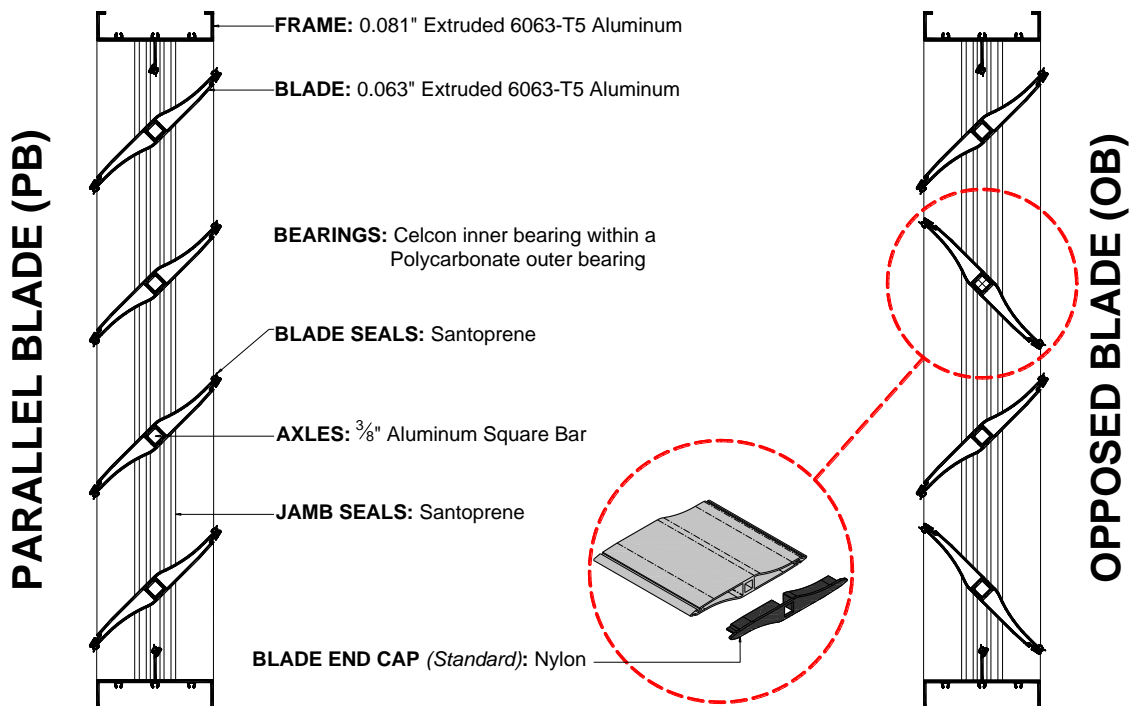

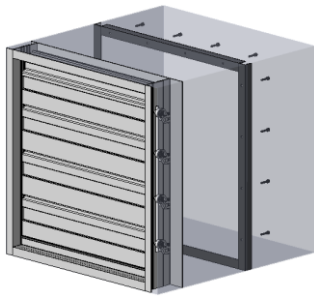

3160 – Duct-Mount

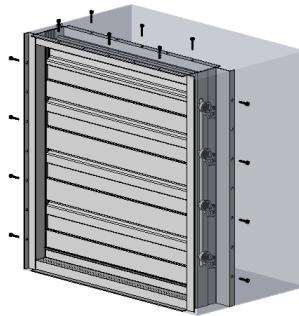

3161 – Duct-Mount

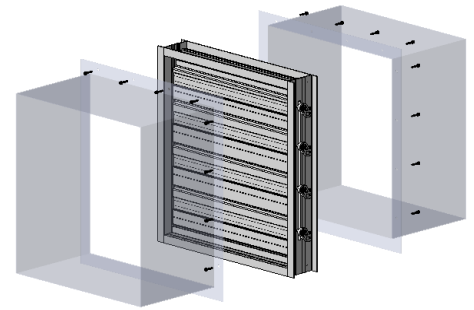

3165 – Flanged-to-Duct

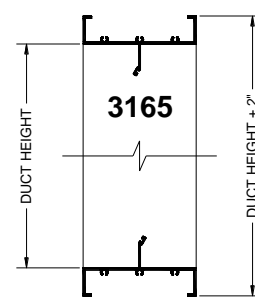
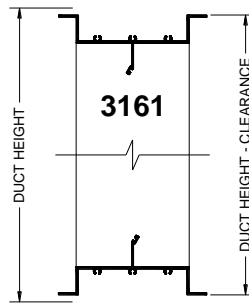
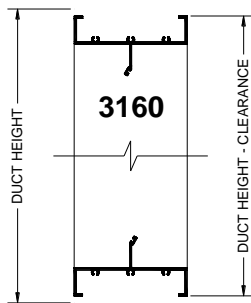

For Duct-Mount Frame specify: 3160 / 3161
For Flanged-to-Duct Frame specify: 3165

*For Models 3160 and 3161:
Clearance = 1/4" Overall for Single Panel Construction
Clearance = 1/2" Overall for Multiple Panel Construction

PRESSURE LIMITATIONS:

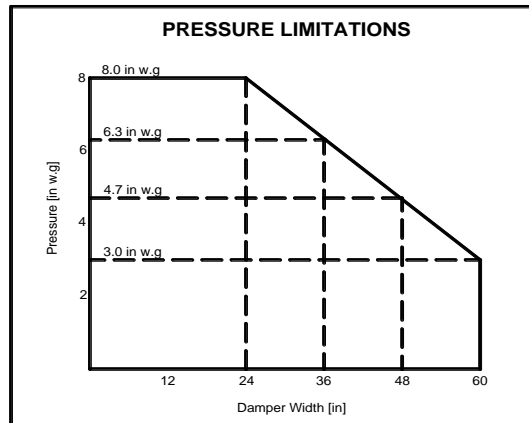

LEAKAGE DATA:

MAXIMUM DAMPER WIDTH	LEAKAGE CLASS (Opposed Blade Only)		
	@1" w.g. (0.25 kPa)	@4" w.g. (1 kPa)	@8" w.g. (2 kPa)
48" (1219 mm)	1A	1	1

Leakage Class definitions:

The maximum permitted leakage for Class ratings is as follows:

Class 1A: 3 cfm/ft² @ 1" w.g. (Class 1A is only tested at 1" w.g. per AMCA).

Class 1: 4 cfm/ft² @ 1" w.g.

8 cfm/ft² @ 4" w.g.

11 cfm/ft² @ 8" w.g.

Air leakage is based on operation between 0°C-49°C (32°F-120°F).

Data corrected to standard air density of 0.075 lbs./ft³.

Leakage tested in accordance with AMCA Standard 500-D, Fig.5.4A.

Data are based on a torque of 16 in.-lbs./ft² (1.81 N·m) to close and seat the damper during the test.

PRESSURE DROP:

Tested to AMCA Figure 5.3 (Ducted both sides):

12 x 12 (305 x 305)		24 x 24 (610 x 610)		36 x 36 (914 x 914)		48 x 12 (1219 x 305)		12 x 48 (305 x 1219)	
Velocity (fpm)	Pressure Drop (in. w.g.)	Velocity (fpm)	Pressure Drop (in. w.g.)	Velocity (fpm)	Pressure Drop (in. w.g.)	Velocity (fpm)	Pressure Drop (in. w.g.)	Velocity (fpm)	Pressure Drop (in. w.g.)
505	0.011	518	0.008	496	0.004	499	0.007	499	0.005
1001	0.040	990	0.028	1004	0.020	1003	0.027	1004	0.021
1463	0.091	1497	0.061	1495	0.043	1498	0.062	1504	0.048
1958	0.174	2010	0.103	1994	0.070	2002	0.116	2006	0.086
3004	0.422	3016	0.237	3001	0.165	3003	0.267	3001	0.197

Tested to AMCA Figure 5.5 (Inlet chamber, no outlet duct):

12 x 12 (305 x 305)		24 x 24 (610 x 610)		36 x 36 (914 x 914)		48 x 12 (1219 x 305)		12 x 48 (305 x 1219)	
Velocity (fpm)	Pressure Drop (in. w.g.)	Velocity (fpm)	Pressure Drop (in. w.g.)	Velocity (fpm)	Pressure Drop (in. w.g.)	Velocity (fpm)	Pressure Drop (in. w.g.)	Velocity (fpm)	Pressure Drop (in. w.g.)
489	0.051	531	0.055	496	0.045	572	0.052	608	0.086
996	0.196	1013	0.205	1004	0.185	1217	0.248	1241	0.359
1495	0.435	1513	0.467	1497	0.411	1795	0.558	1781	0.737
1986	0.767	2019	0.846	1999	0.741	2443	1.083	2443	1.393
3036	1.805	3004	1.887	3005	1.681	3014	1.758	3001	2.105

Pressure drop tested per AMCA 500-D per set-up figures as indicated above.
Data corrected to standard air density of 0.075 lbs/ft³.



Alumavent Inc. certifies that the Model 3100 shown herein is licensed to bear the AMCA seal. The ratings shown are based on tests and procedures performed in accordance with AMCA Publication 511 and comply with the requirements of the AMCA Certified Ratings Program. The AMCA Certified Ratings Seal applies to air leakage ratings and air performance ratings.

RECOMMENDED SPECIFICATION:

Furnish and install control damper model 3160 / 3161 / 3165 as manufactured by Alumavent Inc., Bolton Ontario. Blades shall be 0.063" (1.60 mm) thick extruded aluminum, hollow airfoil shape. Frames shall be 0.081" (2.06 mm) thick extruded aluminum. Axles shall be 0.375" (9.53 mm) aluminum square bar. Blade and Jamb seals shall be Santoprene (or optional Silicone). Linkage is concealed in frame for models 3160 / 3161 and outside of frame for model 3165. Operating temperature range shall be -40° to +180°F. Leakage and pressure drop performance data submitted to be based on tests in accordance with AMCA Standard 500-D. Dampers must comply with the requirements of AMCA 511 Certified Ratings Program and be qualified to bear the AMCA Seal for Air Performance and Air Leakage. Damper widths from 12" (305 mm) to 48" (1219 mm) must meet leakage Class 1A criteria of maximum 3 cfm/ft² (15.2 L/s/m²) at 1" w.g. (.25 kPa).